

1/10TH SCALE READY-TO-RUN 4WD BRUSHED ELECTRIC MOTOR POWERED OFF ROAD CRAWLER

Mauler



ENGLISH INSTRUCTIONS – PAGE 2
FRANÇAIS INSTRUCTIONS – PAGE 16

INSTRUCTION BOOK AND COMPONENT LISTING



www.ftx-rc.com





FTX Mauler 1/10th Scale 4WD Ready-To-Run Rock Crawler

Congratulations on your purchase of the FTX 'Mauler' electric off road car.

This 1/10th scale model has been factory assembled and all electrics installed and set up to make it the easiest possible introduction to the sport of driving RC cars.

WARNING: Read the ENTIRE instruction manual to become familiar with the features of the product before operating. Failure to operate the product correctly can result in damage to the product, personal property and cause serious injury. This is NOT a toy and must be operated with caution and common sense. Failure to operate this product in a safe and responsible manner could result in damage, injury or damage to other property.

This product is not intended for use by children without direct adult supervision. It is essential to read and follow all the instructions and warnings in the manual, prior to assembly, set-up or use, in order to operate correctly and avoid damage or serious injury.

Safety Precautions and Warnings

- You are responsible for operating this model such that it does not endanger yourself and others, or result in damage to the product or the property of others.
- This model is controlled by a radio which is possibly subject to interference which can cause momentary loss of control so it is advisable to always keep a safe distance to avoid collisions or injury.
- Age Recommendation: 14 years or over. This is not a toy. This product is not intended for use by children without direct adult supervision.

Carefully follow these directions and warnings, plus those of any additional equipment associated with the use of this model, chargers, ESC and motors, radio etc.

- Never operate your model with low transmitter batteries.
- Always operate your model in an open area away from cars, traffic or people.
- Never operate the model in the street or in populated areas.
- Always keep the vehicle in direct line of sight, you cannot control what you cannot see!
- Keep all chemicals, small parts and anything electrical out of the reach of children.
- Although splash-proof the car and electronics are not designed to be subjected to extended moisture exposure or submersion. To do so will result in permanent damage.
- Avoid injury from high speed rotating parts, gears and axles etc.
- Novices should seek advice from more experienced people to operate the model correctly and meet its performance potential.
- Exercise caution when using tools and sharp instruments.
- Do not put fingers or any objects inside rotating and moving parts.
- Take care when carrying out repairs or maintenance as some parts may be sharp.
- Do NOT touch equipment such as the motor, electronic speed control and battery, immediately after using your model because they can generate high temperatures.
- Always turn on your transmitter before you turn on the receiver in the car. Always turn off the receiver before turning your transmitter off.
- Keep the wheels of the model off the ground, and keep your hands away from the wheels when checking the operation of the radio equipment.
- Prolong motor life by preventing overheat conditions. Undue motor wear can result from frequent turns, rapid change of direction forwards/backwards, continuous stop/starts, pushing/pulling objects, driving in deep sand and tall grass, or driving continuously up hill.

Contents:

FTX Mauler Rock Crawler RTR Vehicle
Transmitter: 2.4ghz Steerwheel
Charger: Wall Charger NiMh 500mA
Battery: 2000mAh NiMh 7.2V





Required equipment for operation

1. Tools required for building and maintenance:

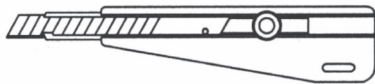

● Hobby knife

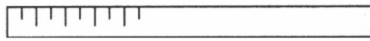

● Precision ruler

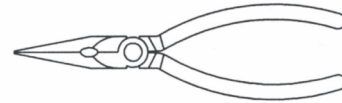

● Needle nose pliers

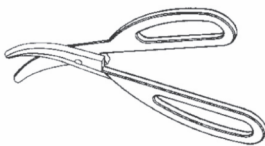

● Lexan scissors

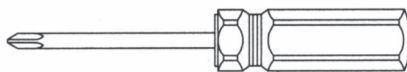

● Flat and Philips screwdriver

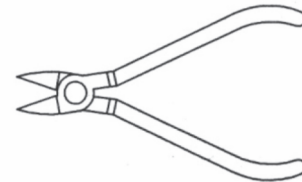
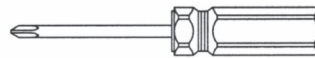

● Wire cutters

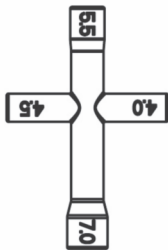

● Cross wrench

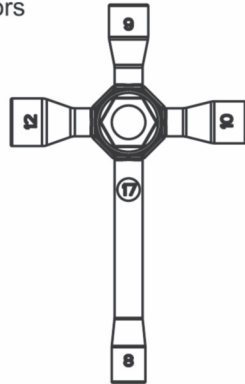

● Cross wrench



● CA glue&rubber cement



● Thread locking compound



1.5mm



2.0mm



2.5mm

● Hex wrench

WARNING!

Do not use a power screw driver to install screws into nylon or plastic materials. The fast locking may heat up the screws being installed that may break the molded parts or strip the threads during installation.

2. Additional items needed for operation:



4 pcs AA Alkaline batteries for transmitter

IMPORTANT!

Check that all screws and nuts are tight before each use.



FAMILIARIZING YOURSELF WITH YOUR 2.4GHZ RADIO SYSTEM

Your car is equipped with a 2.4ghz radio system that once bound with the esc will provide your with interference free use.
Please read and understand the instructions and functions before operating.

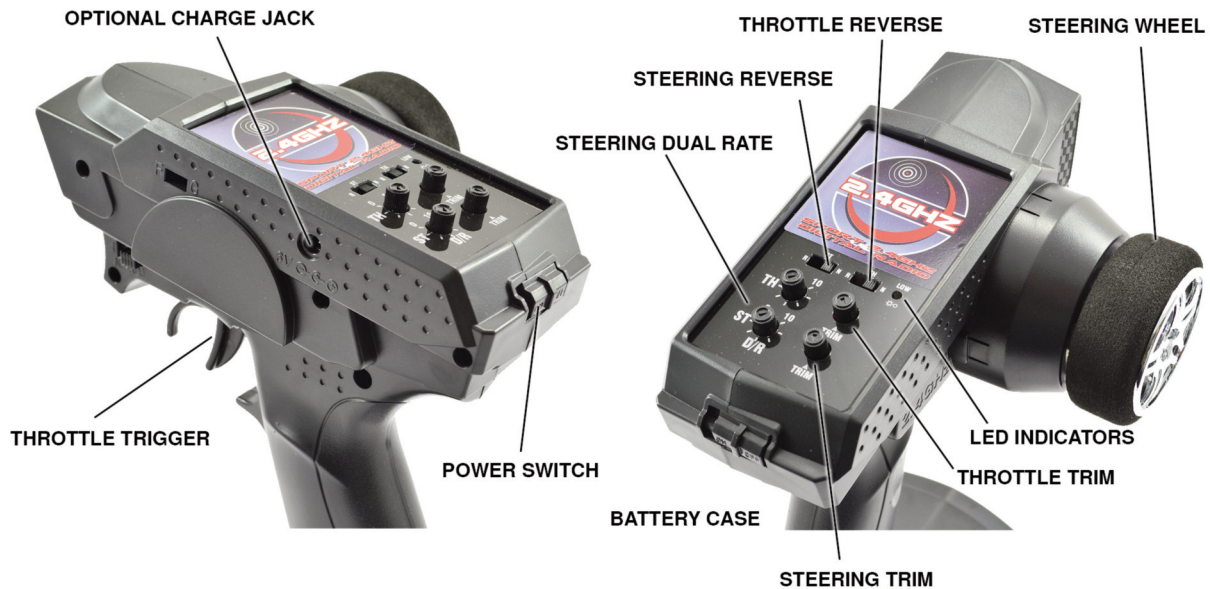

Steering Wheel: Proportionally operates the model left and right

Battery case: Requires 4 x AA batteries.

Power switch: Used to turn the radio ON/OFF

Steering Dual Rate: Allows you to change the amount of steering servo travel compared to the amount of physical steering wheel movement.

Throttle Dual Rate: Allows you to change the amount of throttle movement compared to the amount of physical throttle trigger movement.

Throttle/Steering Trims: Used to adjust the centre trim of the throttle/steering for straight wheels and neutral throttle.

Steering Reverse: Allows you to electronically switch the direction of the steering servo travel. For example if you move the steering wheel to the right and the steering servo moves to the left, flip the steering reverse switch to the steering move to the right.

Throttle Reverse: Allows you to electronically switch the direction that the motor operates in relation to the throttle trigger. For example if you pull the trigger to accelerate forward, but the model goes in reverse, flip the throttle reverse switch to make the model accelerate forward.

Throttle Trigger: Controls the speed and braking ability of your model. Pull back to accelerate, release to decelerate and push out forward for brake. Pushing it a second time activates reverse.

LED Indicators: Show battery power level. Replace batteries when the power indicator blinks or the buzzer beeps.

Charge Jack: Allows for charging of RE-CHARGABLE batteries ONLY via a separate charger.



BATTERY INSTALLATION

1. Slide the battery cover off as shown and install 4 x AA size batteries, positioning the polarity as indicated on the battery box.
2. Replace cover after batteries are installed.

Notes:

- Use batteries of the same type
- Remove batteries when not in use
- Always check battery power before use
- Dispose of exhausted batteries properly
- Only charge rechargeable batteries when using charge jack



RUNNING YOUR CAR

1 TURN ON THE RECEIVER ON YOUR CAR

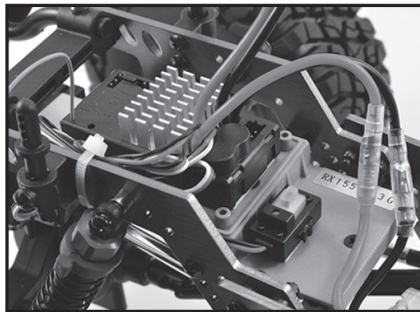

The ESC/receiver switch is located under the bodyshell of the model. Switch on the ESC/Receiver Switch as shown in the picture.

2 TURN ON THE RADIO CONTROLLER

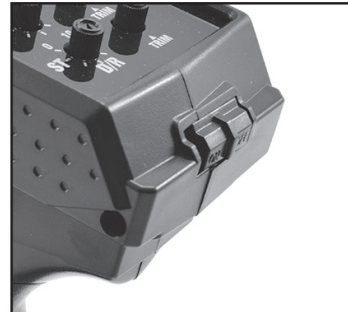

Switch on the power switch on the radio controller. Your car is bound with your radio controller automatically.

3 CHECK STEERING PERFORMANCE

- Ensure good steering performance.

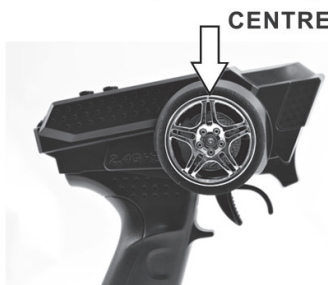

1) To keep the car run straight in line, do not move the control wheel. (Keep it at centre)

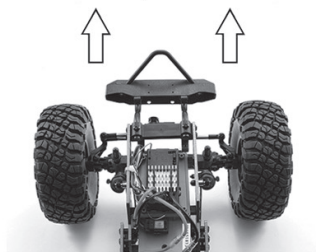

2) Turn it left to allow your vehicle turn to left.



3) Turn it right to allow your vehicle turn to right.



4 CHECK TRIGGER RESPONSE

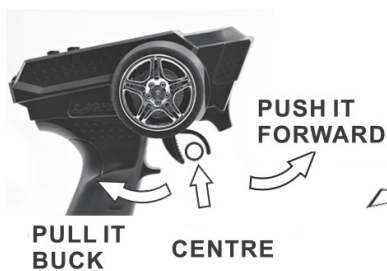

PLEASE NOTE:
THE MODEL SWITCHES BETWEEN FORWARD AND REVERSE INSTANTLY FOR SLOW SPEED MANOEUVABILITY. EXCESSIVE USE OF THIS FEATURE CAN CAUSE TRANSMISSION AND ESC DAMAGE.

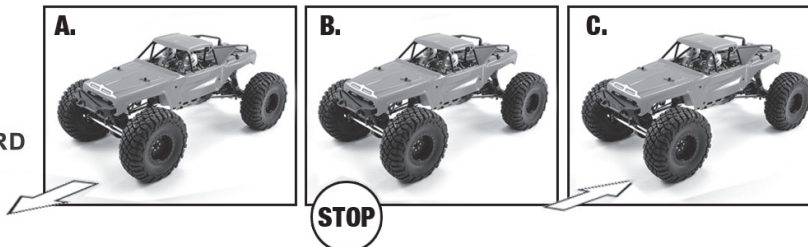

- A. Pull the trigger back to accelerate, release it to decelerate.
- B. To stop running your car, release the trigger to Neutral.
- C. Pushing the trigger forward activates reverse.





RUNNING YOUR CAR

5 TO TUNE THE STEERING TRIM



STEERING TRIM



Gently pull the trigger to allow your car to run slowly. Meantime, tune the steering trim to allow the front wheels to be aligned.

6 TO TUNE THE THROTTLE TRIM

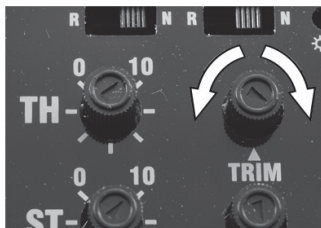

THROTTLE TRIM



Throttle trim is used to set your idle speed.

7 TO TUNE THE STEERING DUAL RATE CONTROL DIAL



STEERING D/R



This dial adjusts the overall travel of the steering servo. Push the dial forward for maximum steering. Pull the dial back to reduce the steering level.

- Set the Steering Dual Rate Control Dial to Minimum first. To set the desired steering level increase it again whilst decelerating your vehicle.

8 STEERING/THROTTLE REVERSE

Steering Reverse: It allows you to electronically switch the direction of steering servo travel. For example, if you move the steering wheel to the right and the steering servo moves to the left, flip the Steering Reverse Switch to make the steering servo move to the left.

N: Normal
R: Reverse

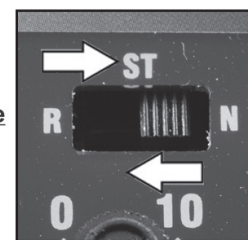

Throttle Reverse : It allows you to electronically switch the direction that the motor operates in relation to the throttle trigger. For example, if you pull the throttle trigger to accelerate forward, but the model goes in reverse, flip the Throttle Reverse Switch to make the model accelerate forward.

N: Normal
R: Reverse

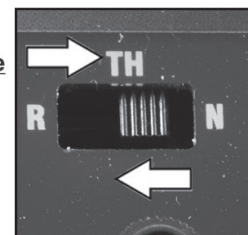



SPEED CONTROL CONNECTION DIAGRAM

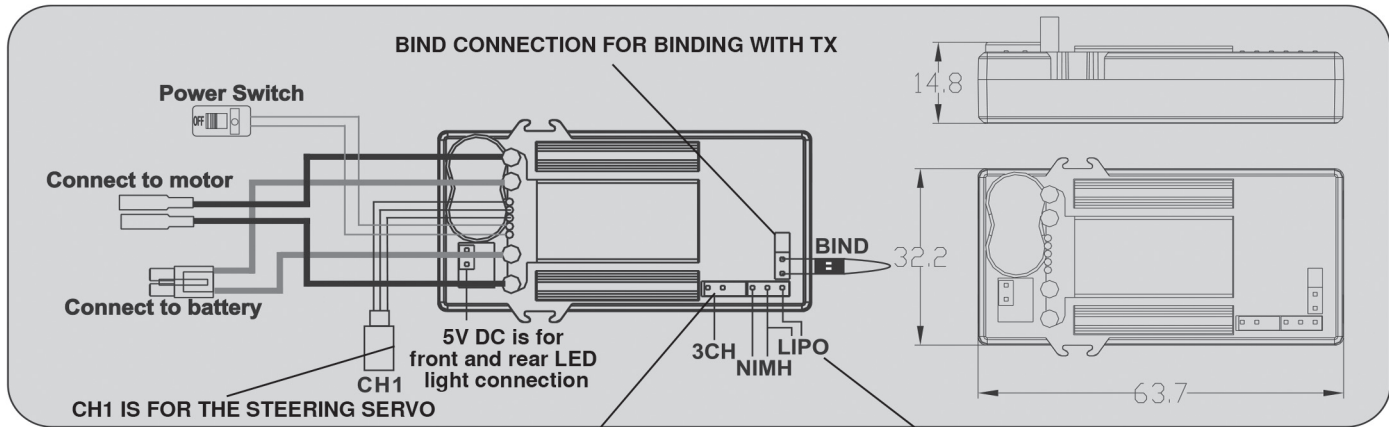



OPTIONAL 3CH AVAILABLE FOR ROOF LIGHTS, WINCH ETC THAT CAN BE CONTROLLED VIA A ALTERNATIVE 3-CHANNEL TRANSMITTER.

ESC CAN BE SWITCHED FOR NIMH OR LIPO BATTERY COMPATABILITY. BY SWITCHING THE PLASTIC PLUG YOU CAN CHANGE THE ESC'S BATTERY SETTING. LOOKING AT THE DIAGRAM, IF THE PLUG IS IN THE LEFT SIDE TWO PINS, THEN THIS IS FOR NIMH. IF PLUGGED INTO THE RIGHT SIDE TWO PINS IT IS SET FOR LIPO 2S ONLY WITH A VOLTAGE CUT-OFF.

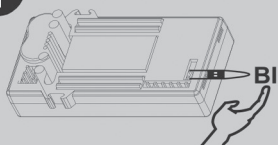
BINDING THE TRANSMITTER AND RECEIVER

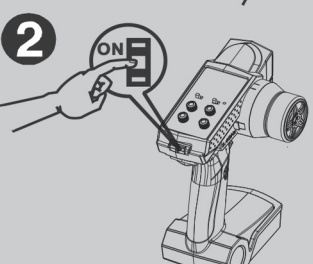
- 

1. After connecting the 2-in-1 Unit to the battery pack, then plug in the bind connector into the Bind port. The LED on the Speed control unit should start to flash rapidly.
- 

2. Switch on the transmitter then pull the 'bind' connector out of the receiver.
- 

3. The LED on the 2-in-1 unit should become solid. This will indicate that a solid connection has been achieved between the transmitter and 2-in-1 unit. They are now bound together.

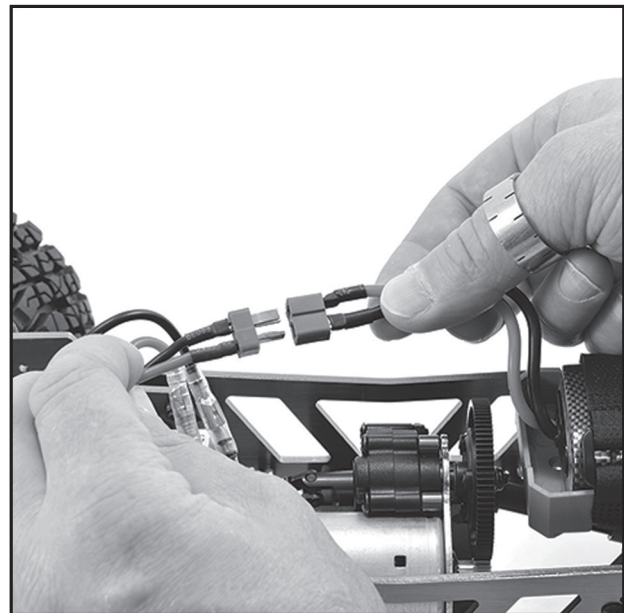

CHARGING/INSTALLING THE BATTERY.

Always store your model with the battery pack unplugged and removed. Always charge your battery away from the vehicle. The included 500mAh mains charger will take approx 3 hours to charge a fully discharged battery, but always remove it from the charger if it becomes warm to the touch. Always disconnect the charger from the mains supply and the battery pack when not in use. Keep children away from charger and battery during the charging process.



NOTES ON BATTERY USE:

Always allow the battery cool after use, before recharging. Always inspect the battery before charging. Any bare wires, split heat shrink or leakage is a sure sign of abuse.

Never attempt to charge dead or damaged batteries. Do not disassemble the battery or cut the connector wires. If the battery connector gets hot enough to melt there is most likely a serious problem with your model, driveline, battery wires or speed controller. Find and correct the problem before installing another charged battery pack.

NEVER charge the battery unattended incase of overcharging, you need to be able to monitor the battery during charging. Charge away from flammable objects and on a non-flammable surface incase the battery becomes too hot.



MAINTAINING YOUR CAR

After running your car, the following procedures should be performed regularly and will help to maintain your car's performance.

- Inspect your car for any obvious damage.
- Check the gears for wear, debris or broken/slipping teeth.
- Check the wheels and tighten the wheel screws properly.
- Check for loose screws in the chassis.
- Check the wiring for frayed or damaged wires or connectors.
- Check the steering servo which will wear out over time and require replacement.
- Check all batteries.
- Keep the chassis clean and free of sand, dust and moisture.
- Remove and clean the motor if necessary. (Never attempt to re-assemble the motor, you will damage it and void the warranty).
- Clean the car body with a soft lint-free cloth.
- Remove all batteries when not in use.

TROUBLESHOOTING

- | | |
|---|--|
| A. The vehicle does not work at all. | <div style="border-left: 1px solid black; border-right: 1px solid black; padding: 0 5px;">1. Check to see if transmitter and car are on.</div> <div style="border-left: 1px solid black; border-right: 1px solid black; padding: 0 5px;">2. Replace batteries.</div> <div style="border-left: 1px solid black; border-right: 1px solid black; padding: 0 5px;">3. Check if there are damaged parts.</div> |
| B. The vehicle runs slow. | <div style="border-left: 1px solid black; border-right: 1px solid black; padding: 0 5px;">1. Replace or charge the battery pack and/or the radio batteries.</div> <div style="border-left: 1px solid black; border-right: 1px solid black; padding: 0 5px;">2. Make sure the vehicle is geared properly and the pinion and spur gear are over tightened.</div> <div style="border-left: 1px solid black; border-right: 1px solid black; padding: 0 5px;">3. Clean all bushings or ball bearings.</div> <div style="border-left: 1px solid black; border-right: 1px solid black; padding: 0 5px;">4. Check for stripped or dirty gears.</div> |
| C. The throttle works, but not the steering. | <div style="border-left: 1px solid black; border-right: 1px solid black; padding: 0 5px;">1. Check if the servo feels jammed, try centering it by hand.</div> <div style="border-left: 1px solid black; border-right: 1px solid black; padding: 0 5px;">2. Check the whole steering system.</div> |
| D. It steers, but throttle is uncontrollable. | <div style="border-left: 1px solid black; border-right: 1px solid black; padding: 0 5px;">1. Check if there are damaged parts.</div> <div style="border-left: 1px solid black; border-right: 1px solid black; padding: 0 5px;">2. Replace or charge the battery pack and/or the radio batteries.</div> |
| E. The vehicle runs noisily. | <div style="border-left: 1px solid black; border-right: 1px solid black; padding: 0 5px;">1. Check gear mesh between spur gear and pinion.</div> <div style="border-left: 1px solid black; border-right: 1px solid black; padding: 0 5px;">2. Check for stripped and/or dirty gears.</div> <div style="border-left: 1px solid black; border-right: 1px solid black; padding: 0 5px;">3. Clean and oil bushings or ball bearings.</div> |















Spare Part

<p>FTX8750 – Front and Rear Axle Housing (2pcs)</p> 	<p>FTX8751 – Centre Link Mount (2pcs)</p> 	<p>FTX8752 – Steering Block Carriers & Bushings (2pcs)</p> 	<p>FTX8753 – Front Hub Carriers (2pcs)</p> 
<p>FTX8754 – Aluminium Servo Plate w/Mount</p> 	<p>FTX8755 – Chassis Skid Plate</p> 	<p>FTX8757 – Front & rear Universal Main Drive Shaft</p> 	<p>VZ0014D – Battery Pack (Ni-MH 7.2V 2400mAH)</p>  <p>Deans connector</p>
<p>FTX8756 – Complete Built Transmission Set</p> 	 <p>(20T) (28T) (5*18mm) (10*42mm) (87T) (53T) (2*9mm) (10*35mm) (2.5*17mm)</p> <p>include the above parts</p>		<p>FTX8758 – 87T Main Gear Set</p> 
<p>FTX8759 – Transmission Gear Set (20T, 28T & 53T)</p> 	<p>FTX8760 – Transmission Gear Housing Set</p> 	<p>FTX8790 – Front/Rear Axle Pinion & Ring Metal Gear Set (38T+13T)</p> 	<p>FTX8761 – Front & Rear Solid Axle Hub</p> 
<p>FTX8791 – Transmission gear hardware set (shaft & pin)</p> 	<p>FTX8767 – Front Bumper w/winch Mount & LED Light Holder</p> 	<p>FTX8768 – Body Post Set (8pcs)</p> 	<p>FTX8769 – Front Bumper Mount & Chassis Holder Set (6pcs)</p> 
<p>FTX8770 – Chassis Brace Set (7pcs)</p> 	<p>FTX8771 – Battery tray, ESC tray with cover</p> 	<p>FTX8772 – Rear Axle Covers (2pcs)</p> 	<p>FTX8785 – Complete Shock Absorbers (pr)</p> 
<p>FTX8786 – Shock Springs Medium (4pcs)</p> 	<p>FTX8773 – Suspension Ball Cup Set (24pcs)</p> 	<p>FTX8774 – Shock Plastic Parts Set</p> 	<p>FTX8781 – Aluminium Anodised Chassis Plate Set (6pcs)</p> 

















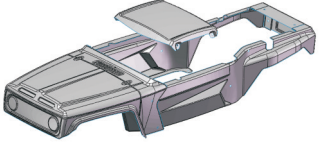
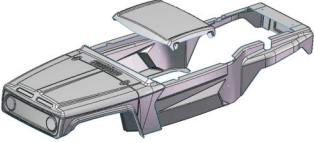
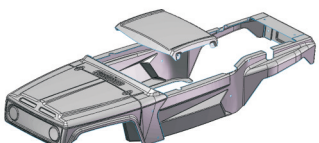











Spare Part

<p>FTX8780 – Aluminium Motor Mount with Mounting Bushes</p> 	<p>FTX8789 – Front Wheel Axles (2pcs)</p> 	<p>FTX8779 – Aluminium 12mm Wheel Hub (4pcs)</p> 	<p>FTX8782 – Steel Centre Link Rods 72mm (2pcs)</p> 
<p>FTX8783 – Steel Axle Link Rods 109mm (2pcs)</p> 	<p>FTX8784 – Steel Steering & Servo Link (128mm & 50mm)</p> 	<p>FTX8787 – Front Wheel Drive Shaft L:84mm, R:75.5mm (2pcs)</p> 	<p>FTX8788 – Rear Drive Shaft 120mm (2pcs)</p> 
<p>FTX8795 – 14T 48DP Motor Pinion Gear</p> 	<p>FTX8802 – High Torque 540 20T Motor</p> 	<p>FTX8775 – Underbody Roll Cage</p> 	<p>FTX8778 – Finished Cockpit Set</p> 
<p>FTX8762G – Grey Wheels (pr)</p> 	<p>FTX8762B – Black Wheels (pr)</p> 	<p>FTX8762C – Chrome Wheels (pr)</p> 	<p>FTX8763 – 2.2" All Terrain Tyres (pr)</p> 
<p>FTX8764 – 2.2" Crawler Memory Foam (pr)</p> 	<p>FTX8765 – 2.2" All Terrain Tyres w/Memory Foam (pr)</p> 	<p>FTX8766G – 2.2" Tyres Pre-Glued on Grey Wheels (pr)</p> 	<p>FTX8766B – 2.2" Tyres Pre-Glued on Black Wheels (pr)</p> 
<p>FTX8766C – 2.2" Tyres Pre-Glued on ChromeWheels (pr)</p> 	<p>FTX8792 – Steering Spindle Bushing (8pcs)</p> 	<p>FTX8794 – Ball Stud (Long) (8pcs)</p> 	<p>FTX8793 – Ball Stud (Short) (8pcs)</p> 
<p>FAST213 – Body clip</p> 	<p>FTX8796 – LED light</p> 	<p>FTX8801 – 2-in-1 Brushed ESC & Receiver</p> 	





Spare Part

<p>FTX8178 – 2.4ghz Transmitter</p> 		<p>FTX8179UK – FTX8179EU Wall Charger</p> 	<p>FTX8803 – 9kg MG Waterproof Servo</p> 	
	<p>FTX8776R – 1 Body Panels Dayglo Red</p> 	<p>FTX8776Y – 2 Body Panels Dayglo Yellow</p> 	<p>FTX8777 – 3 Body Panels Clear Lexan</p> 	
<p>Hardware</p>				
<p>FTX8223 – Pin 2x10</p> 	<p>FTX8809 – O ring locker</p> 	<p>FTX8204 – E-clips ϕ 3.2</p> 	<p>FTX8810 – E-clips ϕ 4.0</p> 	<p>FTBB14 – Ball bearings (5x10x4)</p> 
<p>FTBB10 – Ball bearings (10x15x4)</p> 	<p>FASTM3 – Nylon nuts M3</p> 	<p>FASTM4 – Nylon nuts M4</p> 	<p>FTM4BKF – Wheel locknut M4</p> 	<p>FTX8812 – Column head self-tapping screw 2x5mm</p> 
<p>FTX8811 – Round head self-tapping screw 2.5x10mm</p> 	<p>FTX8814 – Cap head machine screw M3x8mm</p> 	<p>FTX8815 – Cap head machine screw M3x10mm</p> 	<p>FTX8816 – Cap head machine screw M3x12mm</p> 	<p>FTX8217 – Cap head machine screw M3x14mm</p> 
<p>FTX8817 – Caphead self-tapping screw 2.5x10mm</p> 	<p>FTX8818 – Caphead machine screw M3x20mm</p> 	<p>FTX8820 – Caphead machine screw M3x26mm</p> 	<p>FTX8220 – Caphead machine screw M4x8mm</p> 	<p>FTX8821 – Countersunk head machine screw M3x10mm 8P</p> 
<p>FAST123A – Grub hex screw M4x4mm</p> 	<p>FAST123 – Grub hex screw M3x3mm</p> 			





Upgrade Option Parts

FTX8830 – Aluminium Centre Link Ball Mounts (2pcs)



FTX8831 – Aluminium Caster Mounts (2pcs)



FTX8832 – Aluminium Steering Arm L/R (2pcs)

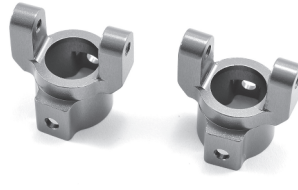

FTX8833 – Aluminium Centre Chassis Plate

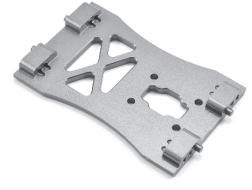

FTX8834 – Connect box (w/gear 38T) (aluminium)



FTX8835 – Aluminium Servo Mount

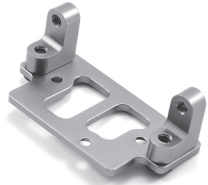

FTX8837 – Aluminium Gearbox Casing

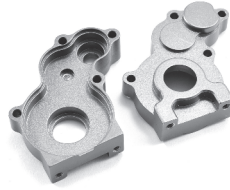

FTX8836 – Aluminium Wheel Hex w/Pins (4pcs)





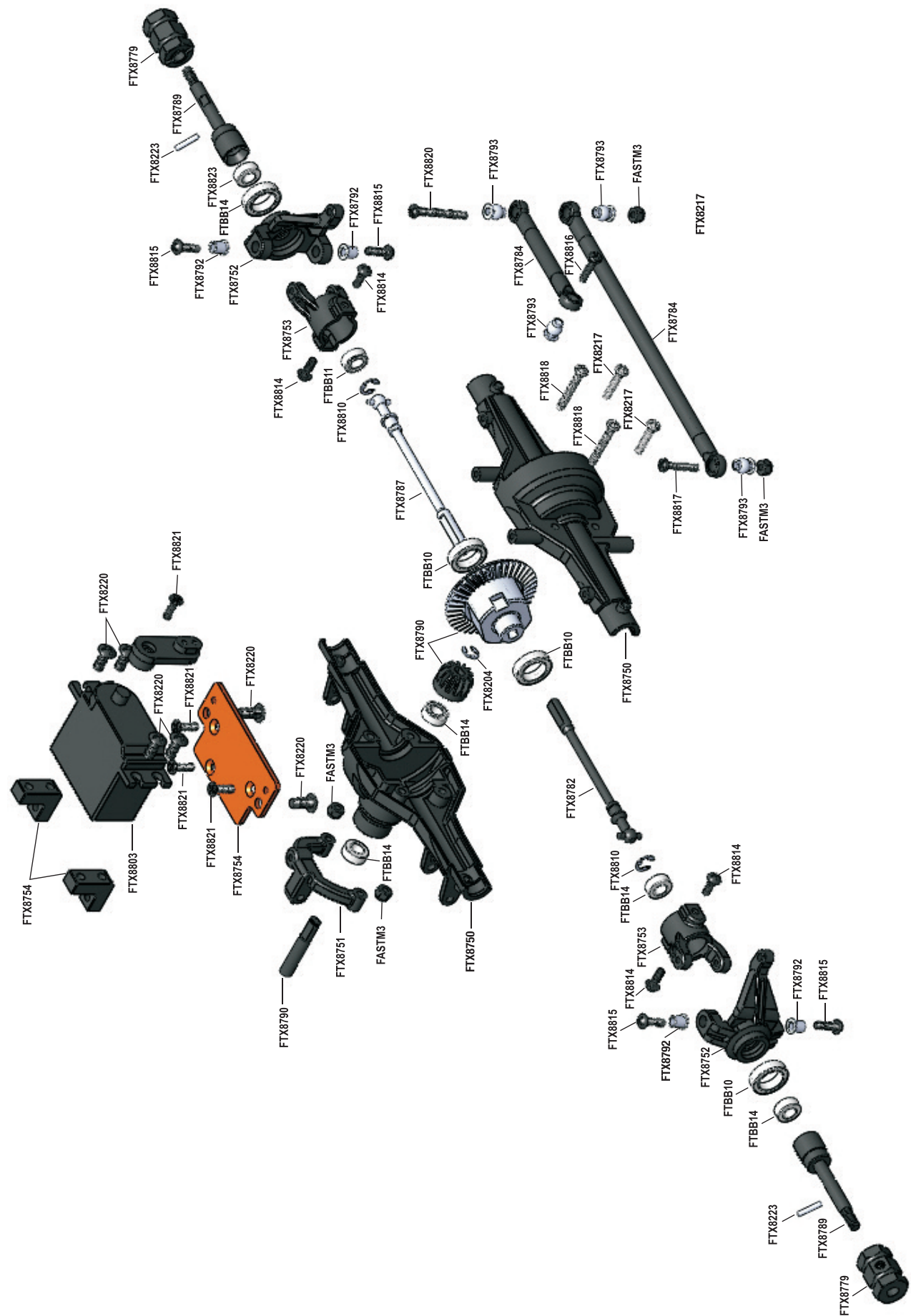

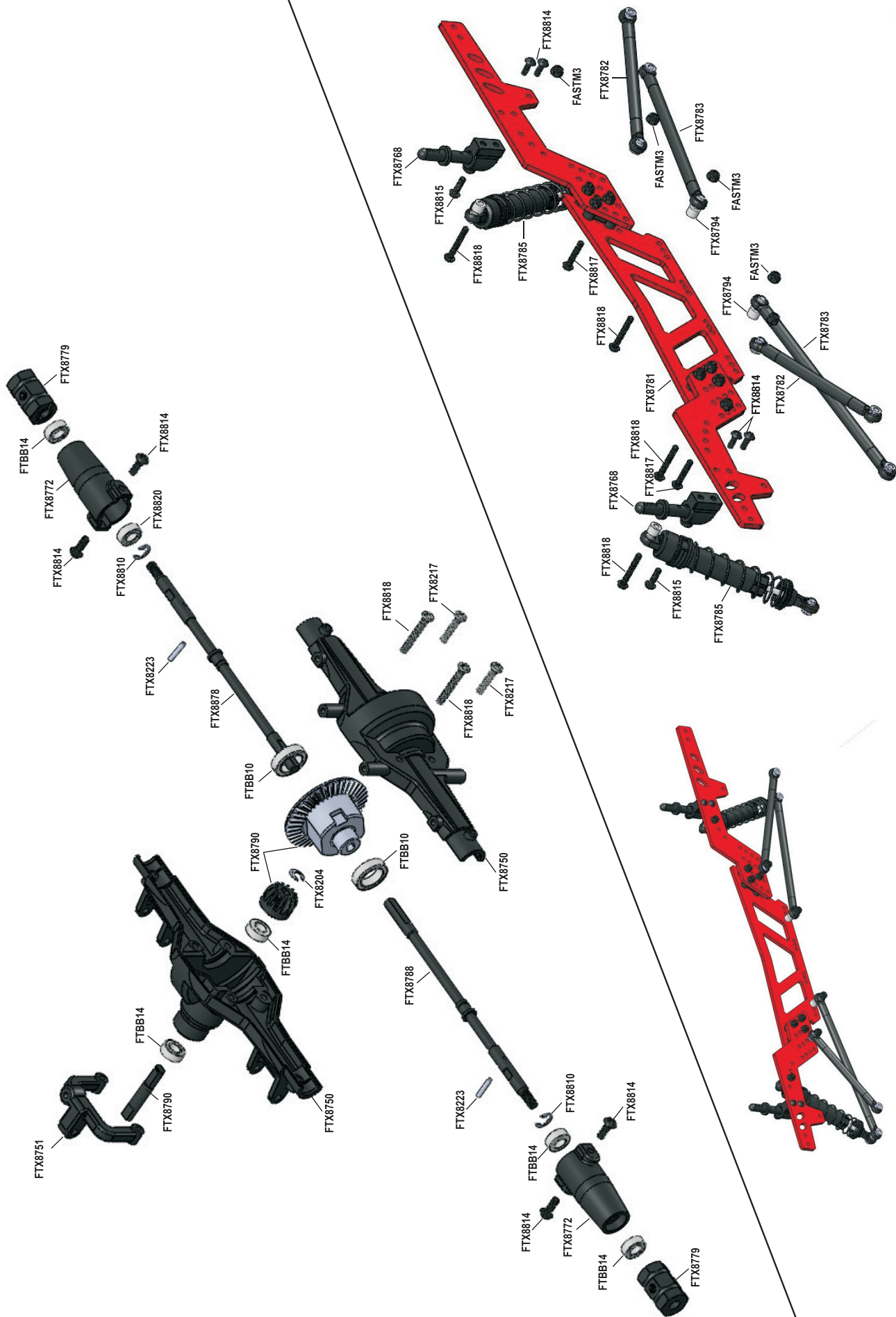

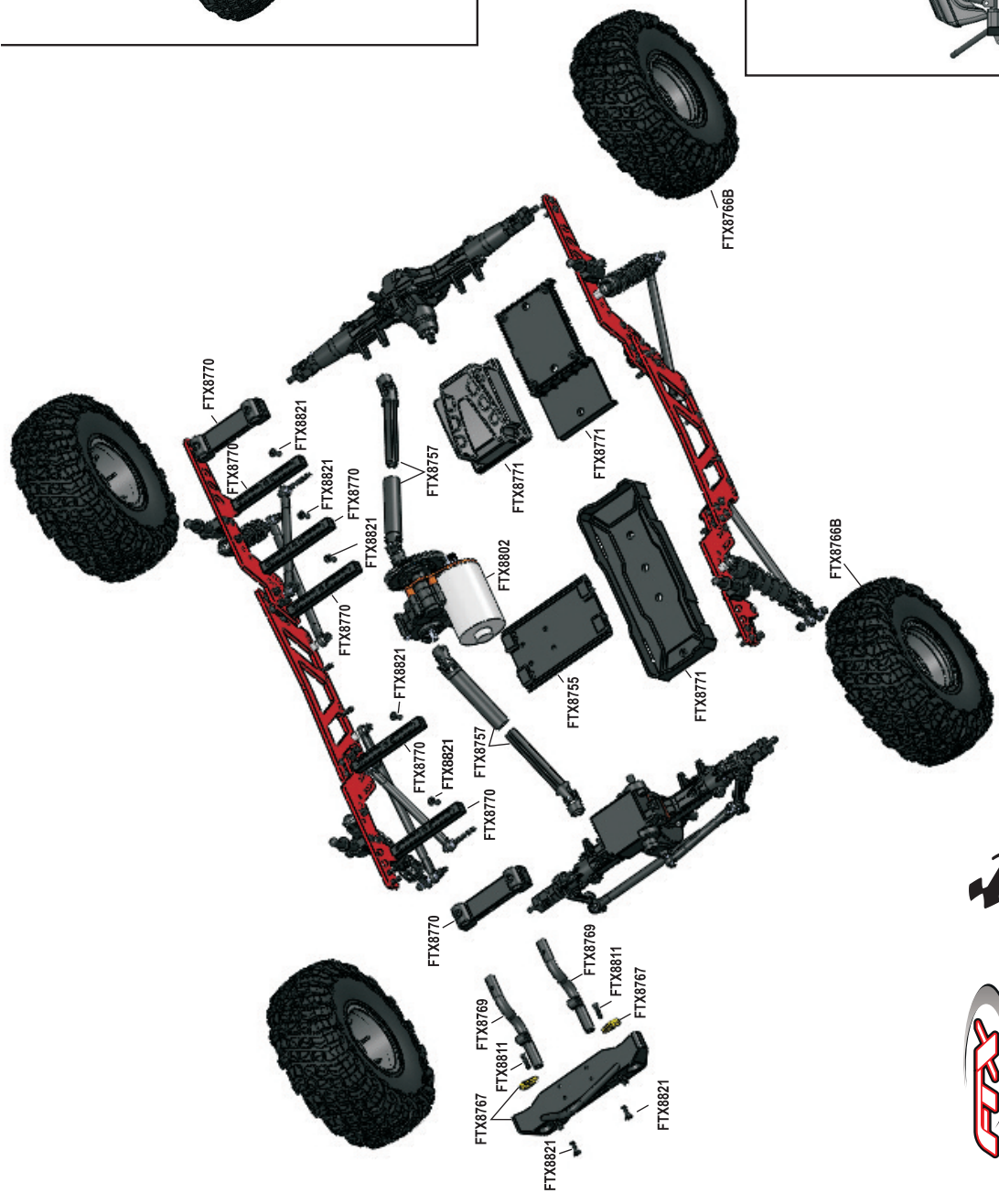
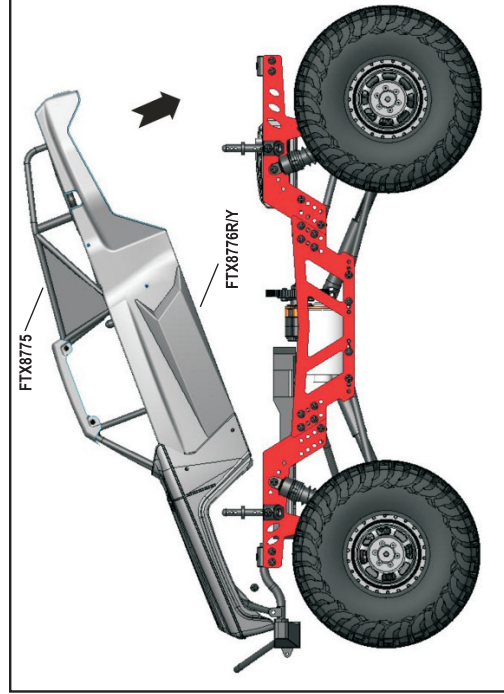
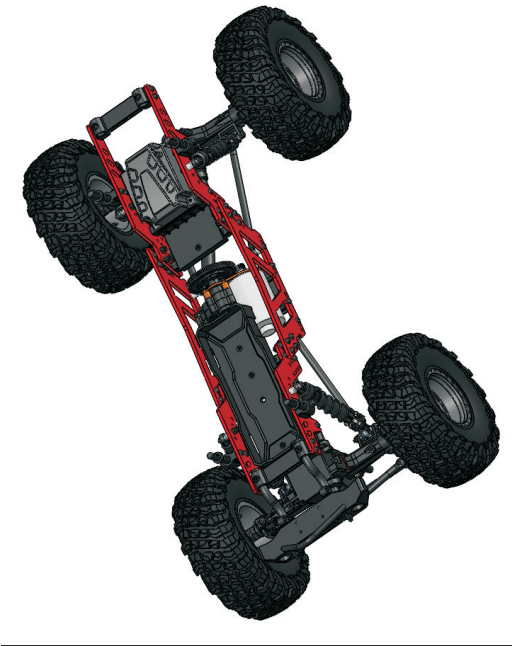

FTX
Mauler
1:10th Scale
Electric 4WD
Rock Crawler





FTX Mauler, 1/10ème RTR prêt à rouler

Merci d'avoir choisi le FTX Mauler Trail 4x4 électrique.

Ce modèle est monté d'usine, l'électronique est pré installée et réglée pour permettre un démarrage et du plaisir le plus rapidement possible.

ATTENTION: lisez l'intégralité du manuel pour exploiter au mieux la voiture et éviter des dommages mécaniques ou corporels. Ce modèle n'est pas un jouet, il doit être manipulé avec précaution. Utilisé dans de mauvaises conditions, ce modèle peut causer des dommages.

Ce modèle n'est pas fait pour être utilisé par un enfant sans la surveillance directe d'un adulte.

Il est essentiel de lire et de suivre les instructions et les recommandations de ce manuel pour entretenir et faire évoluer votre modèle dans de bonnes conditions.

Mesures de sécurité:

- Vous êtes responsable lors de l'évolution de ce modèle, veillez à ne pas vous mettre en danger, à mettre en danger le modèle ou la propriété d'autrui.
- Ce modèle radiocommandé peut être perturbé par d'autres sources d'onde radio, ce qui peut entraîner la perte momentanée du contrôle de la voiture.
- Age recommandé : 14 ans, ceci n'est pas un jouet, ce produit n'est pas fait pour être utilisé par un enfant sans surveillance.



Suivez consciencieusement les instructions suivantes :

- Ne jamais évoluer avec des batteries d'émission faibles
- Toujours évoluer dans une zone dégagée, loin de la circulation et de la foule
- Ne jamais évoluer dans une rue ou un endroit fréquenté
- Toujours garder le modèle dans son champ de vision
- Gardez hors de portée des enfants tous les composants de petite taille, électriques ou chimiques
- Tenez le modèle hors de portée de l'eau (la rouille peut causer des dommages irréversibles au modèle)
- Faites attention aux pièces en rotations, axes, pignons etc.
- Les débutants doivent prendre conseil auprès de personnes plus expérimentées
- Faites attention lors de l'utilisation des outils
- Attention à ne pas mettre les doigts ou d'autres parties du corps en contact avec les pièces en rotation
- Faites attention lors du transport, de la maintenance ou de la réparation, certaines pièces peuvent être coupantes.
- NE JAMAIS toucher les composants tels que le moteur, le variateur ou les batteries après utilisation, ces pièces peuvent être chaudes
- Lorsque vous changez de fréquence d'émission assurez-vous que les quartz de fréquence sont bien positionnés (RX pour récepteur et TX pour l'émetteur)
- Toujours éteindre en premier la voiture avant l'émetteur
- Vérifiez le bon fonctionnement de la voiture les roues dans le vide (en prenant les précautions nécessaires)
- Prolongez la durée de vie du moteur en le préservant de la surchauffe (la durée de vie du moteur dépend aussi de la fréquence de roulage, des changements rapide de direction avant/arrière, des conditions de roulage difficiles poussière/boue des utilisations abusives tirer/pousser des objets)

Contenu:

- 1 FTX Mauler Trail 1/10ème prêt à rouler électrique
- 1 Emetteur à volant fréquence 2.4GHz
- 1 Chargeur: entré 240V sortie 500mA
- 1 Batterie: 7.2V 1500mAh NiMH



Equipements requis pour la maintenance:

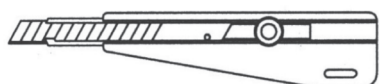

● Cutter

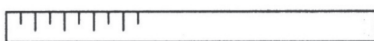

● Règle

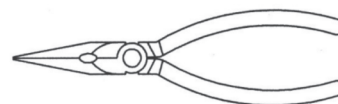

● Pince

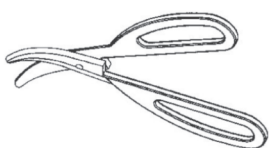

● Ciseaux à lexan

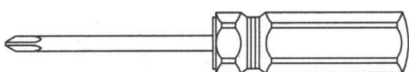

● Tournevis plats et cruciformes

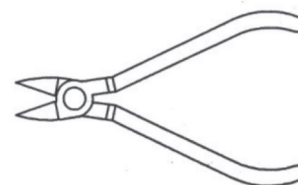
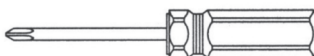

● Pince coupante

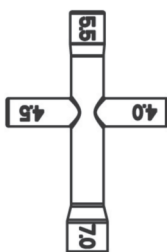

● Clé

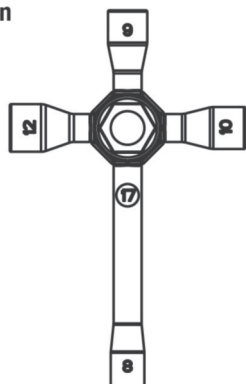

● Colle à pneu



● Frein filet

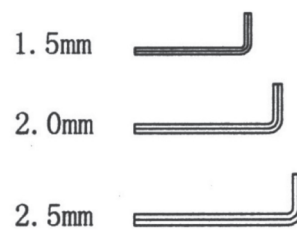

● Clé Allen

ATTENTION: L'utilisation d'une visseuse électrique pour la maintenance pourrait endommager l'emprunte des vis ou casser des pièces du modèle.



4 piles alcalines AA pour l'émetteur

IMPORTANT: Veuillez vérifier le serrage de chaque vis et écrous avant l'utilisation du modèle.



CONTROLE DE LA RADIO INSTRUCTIONS D'INSTALLATION

Votre voiture est maintenant équipée avec la nouvelle radio 2.4GHz. S'il vous plait lisez et comprenez toutes les instructions ci-dessous avant utilisation.

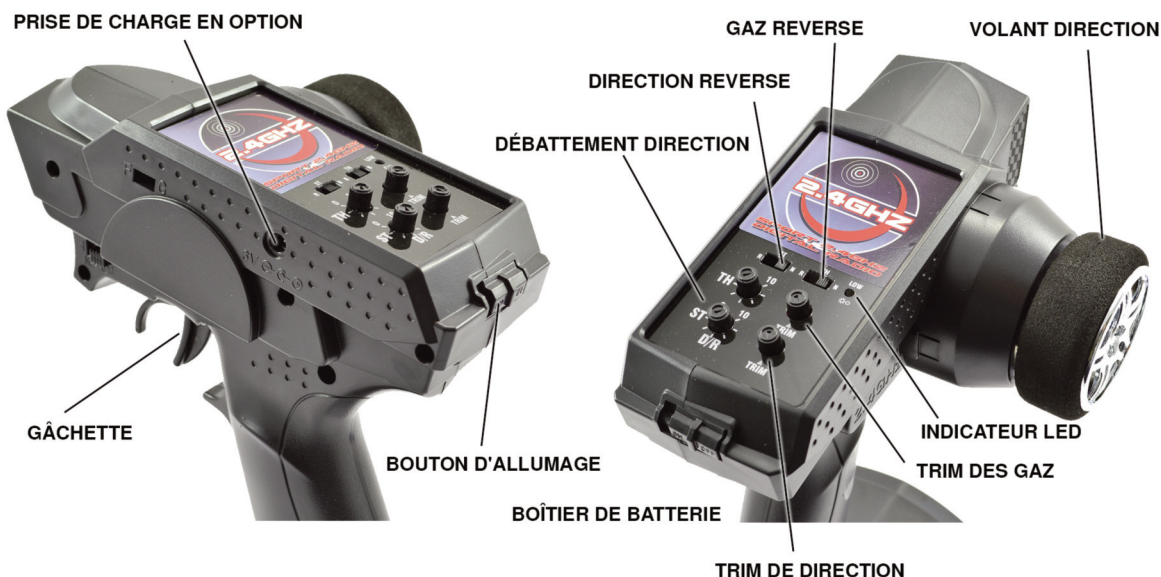

Volant de direction: Proportionnel il permet le contrôle du model gauche et droite.

Logement batterie: Il requiert batterie de type AA.

Bouton d'allumage: Il permet de mettre la radio sur ON ou sur OFF

Réglage débattement de direction: Cela permet de changer la course du servo comparé au mouvement physique du volant de direction.

Trim Gaz/Direction: Ils sont utilisés pour ajuster le centrage des Trim Gaz et direction.

Direction Reverse: Cela permet électroniquement d'inverser le sens de rotation du servo. Par exemple si vous si vous tournez le volant à droite et que le servo va à gauche, inverser le direction Reverse vous permettra d'avoir le servo qui va à droite.

Gaz Reverse: Cela vous permet de changer électroniquement la direction dans laquelle le moteur opère en relation avec la gâchette des Gaz. Par exemple, si vous poussez la gâchette pour accélérer en avant, mais le model va en arrière, inverser le Gaz Reverse permettra au model d'accélérer en avant.

Gâchette: Elle contrôle la vitesse et le frein de votre voiture. Tirer la pour accélérer, lâchez la pour décélérer et poussez la pour freiner. Pousser une seconde fois active la fonction marche arrière.

Indicateurs: Il montre le niveau de batterie. Si le voyant vert est clignote, la batterie n'est pas assez chargée. Si les voyants rouge et vert clignotent en même temps la radio ne va pas tarder à couper, la batterie est totalement vide, la remplacer par une neuve immédiatement.

Bouton de couplage/appairage: Il est utilisé pour coupler votre radio 2,4Ghz et votre récepteur. (Ce bouton n'est pas utilisé longtemps parce votre voiture est automatiquement couplée avec votre Radio dans le kit)

Prise de charge: Permet le rechargement des batteries rechargeables seulement via un chargeur séparé.



INSTALLATION BATTERIE

- 1) Faire glisser le cache comme montré, et faire attention aux polarités comme note, installer 4 batteries AA.
- 2) Replacer le cache après installation.

NOTER:

- Utiliser batteries du même type
- Enlever batterie du compartiment en cas de non utilisation.
- Toujours vérifier le niveau de batterie.
- Recycler vos batteries usagées.
- Chargez uniquement les batteries rechargeables en utilisant la prise de charge



GESTION DE VOTRE VOITURE

1 METTRE SUR ON VOTRE INTERRUPTEUR

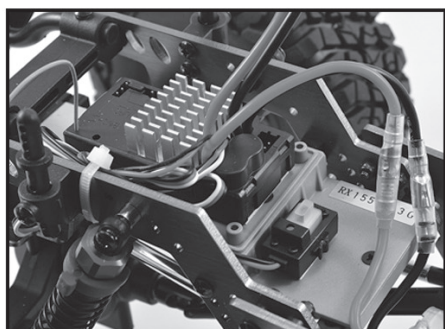

L'ensemble variateur/récepteur se situe à l'arrière de la voiture. Mettre l'interrupteur sur ON comme montré sur la photo.

2 METTRE LA RADIO SUR ON

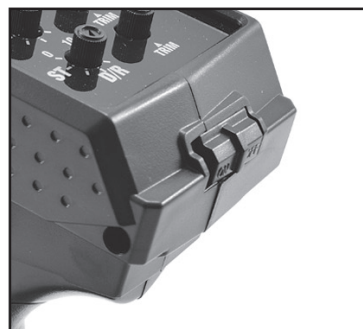

Mettez le bouton d'allumage de la radio sur ON. Votre voiture est automatiquement appairée avec votre Radio.

3. Assurez une bonne performance de pilotage.

CENTRE

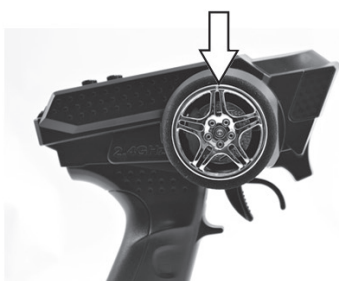

1. Pour que la voiture aille droit ne pas tourner le volant. (le laisser au centre)

TOURNE à GAUCHE



2. Tourner à gauche pour permettre à votre voiture d'aller à gauche.

TOURNE à DROITE



3. Tourner à droite pour permettre à votre voiture d'aller à droite.

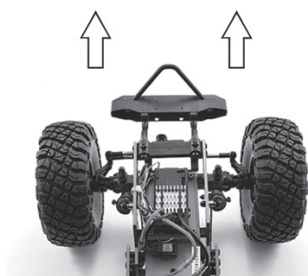

4 Vérifier la réponse de la gâchette

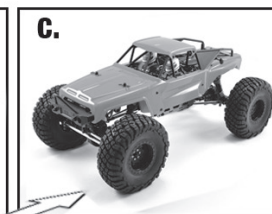
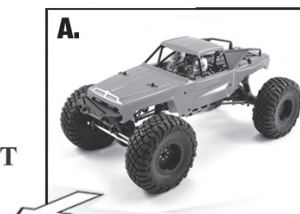

- A. Tirer la gâchette en arrière pour accélérer? La lâcher pour décélérer et la pousser pour freiner.
 B. Pour arrêter la voiture, lâcher la gâchette jusqu'au neutre.
 C. Pousser la gâchette vers l'avant active la marche arrière.

S'IL VOUS PLAÎT NOTEZ :

LE MODÈLE PASSE ENTRE LA MARCHÉ AVANT ET ARRIÈRE INSTANTANÉMENT POUR UNE MANŒVRABILITÉ À FAIBLE VITESSE. UNE UTILISATION EXCESSIVE DE CETTE FONCTIONNALITÉ PEUT ET VA ENDOMMAGER LA TRANSMISSION ET L'ESC.



GESTION DE VOTRE VOITURE

5 POUR MODIFIER LE TRIM DE DIRECTION



TRIM DE DIRECTION



Placer la voiture sur le stand avec les roues qui ne touchent pas le sol, puis régler le Trim de direction pour aligner les roues avant.

6 POUR MODIFIER LE TRIM DE GAZ



TRIM DE GAZ



Trim des gaz est utilisé pour régler la vitesse de ralenti

7 POUR MODIFIER LA COURSE (DIR) DE LA DIRECTION

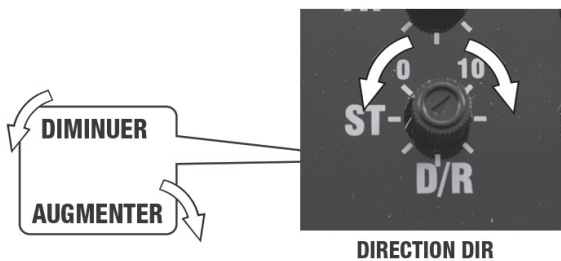

DIRECTION DIR



Ce réglage ajuste la course du servo de direction. Pousser le bouton en avant pour un maximum de directivité. Tirer en arrière pour réduire la course du servo.

Note: Toujours minimiser et augmenter ensuite pendant que votre voiture.

8 REG/AGE DES REVERSES DIRECTION/GAZ

Direction Reverse: Cela permet électroniquement d'inverser le sens de rotation du servo. Par exemple si vous tournez le volant à droite.

N: Normal
R: Reverse

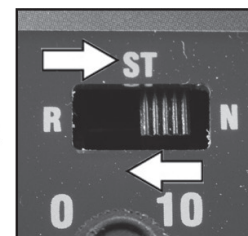

Gaz Reverse: Cela vous permet de changer électroniquement la direction dans laquelle le moteur opère en relation avec la gâchette des Gaz. Par exemple, si vous poussez la gâchette pour accélérer en avant, mais le model va en arrière, inverser le Gaz Reverse permettra au model d'accélérer en avant.

N: Normal
R: Reverse

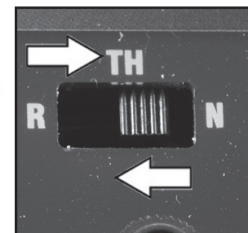



SCHEMA POUR CONNECTER LE CONTROLEUR DE VITESSE

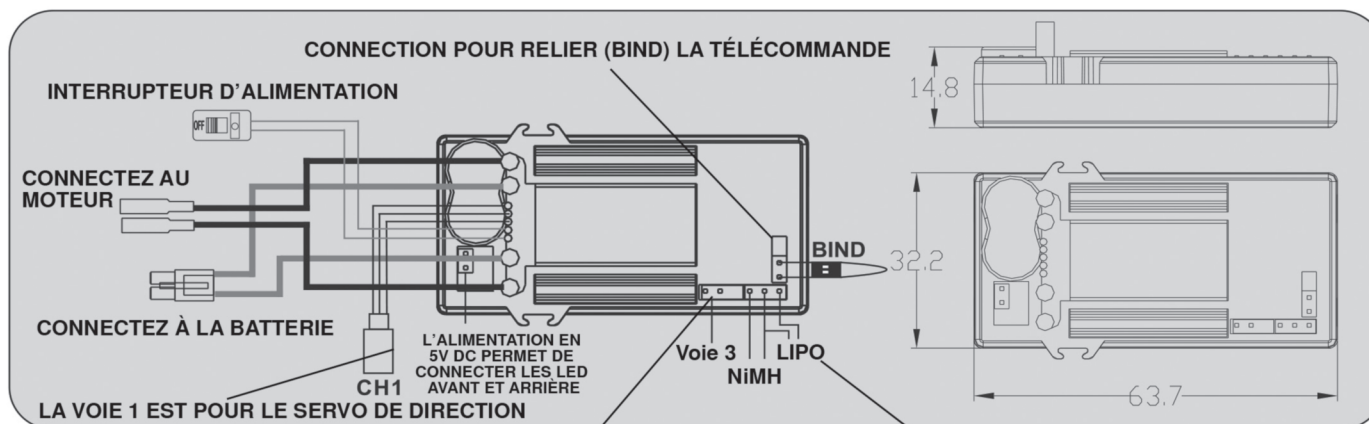

La 3eme voie en option est disponible pour les barres de lumières, treuils, etc et il peut être contrôlé grâce à la 3eme voie de la télécommande

Le contrôleur peut soit être compatible avec les batteries NIMH soit avec les batteries LIPO grâce à la prise, en l'échangeant de position pour choisir le réglage voulu. Regardez sur le schéma, si la prise est branchée sur les 2 pins du côté gauche alors il est réglé pour les batteries NIMH. Et si la prise est branchée sur les 2 pins de droite il est réglé seulement pour les LIPO 2S avec un cut-off.

CONNECTION ENTRE LA TELECOMMANDE ET LE RECEPTEUR

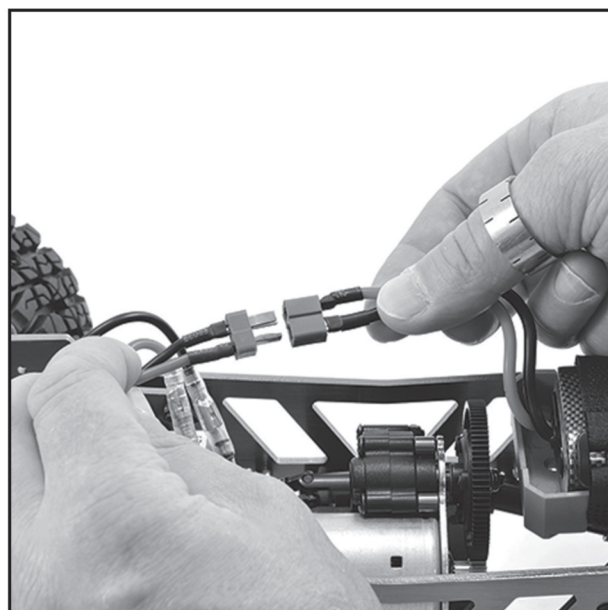
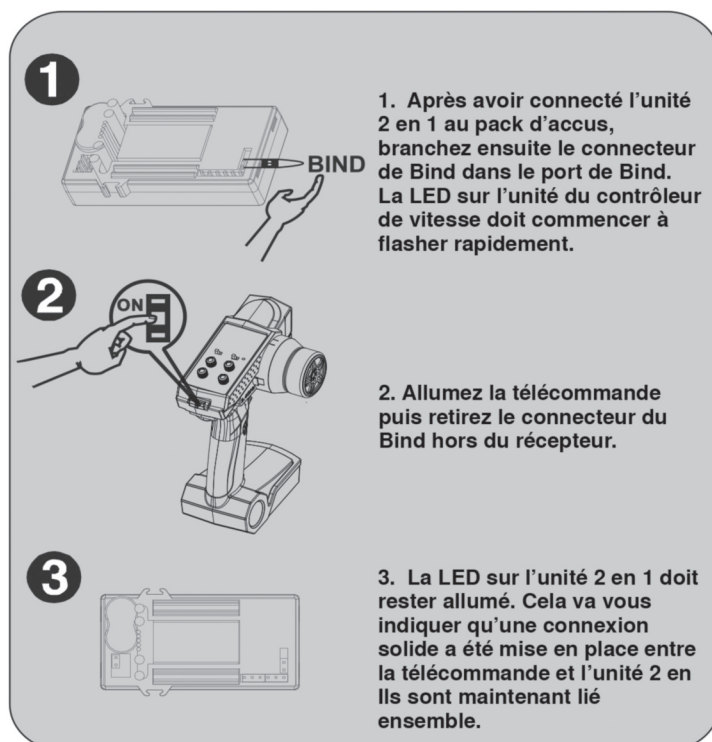

CHARGER / INSTALLER LA BATTERIE

Stocker toujours votre modèle avec le pack de batterie non branché et retiré de votre modèle. Chargez toujours votre batterie loin de votre véhicule. Le chargeur principal de 500mAh inclus va mettre environ 3 heures à charger une batterie complètement déchargée, mais retirez-la toujours du chargeur si elle commence à chauffer au touché.

Et bien sûr déconnectez toujours le chargeur de l'alimentation générale et de la batterie lorsque vous ne vous en servez pas. Gardez les enfants à l'écart du chargeur et de la batterie durant la procédure de charge.



NOTES SUR L'UTILISATION DE LA BATTERIE:

Laissez toujours la batterie refroidir après utilisation, avant de la recharger.
 Inspectez toujours la batterie avant de la recharger.
 Tout fil dénudé, gaine thermo rétractable abimée ou fuite est un signe certain d'abus
 N'essayez jamais de charger une batterie morte ou endommagée.
 Ne désassemblez pas la batterie et ne coupez les fils
 Si les connecteurs de la batterie chauffent jusqu'à fondre, cela signifie qu'il y a un problème sérieux avec votre modèle, la transmission, les câbles de la batterie ou le contrôleur de vitesse. Trouvez et corrigez le problème avant d'installer une autre batterie chargée.
 Ne chargez JAMAIS la batterie sans surveillance en cas de surcharge, vous devez être capable de surveiller la batterie durant la charge.



ENTRETIEN DE LA VOITURE

Après avoir roulé, les procédures suivantes vous permettront d'avoir un véhicule entretenu régulièrement et votre voiture gardera ses performances.

- Inspecter votre véhicule pour voir les dommages évidents.
- Vérifier les pignons, débris ou dents lisses ou cassées.
- Vérifier si les jantes sont serrées et si l'écrou est en bon état.
- Vérifier s'il n'y a pas de vis desserrées sur le châssis.
- Vérifier s'il n'y a pas de fils dénudés ou endommagés, vérifier aussi les connecteurs.
- Vérifier le servo de direction lequel peut nécessiter un remplacement avec les temps.
- Vérifier toutes les batteries.
- Garder le châssis propre sans sable, poussière ou moisissures.
- Démonter et nettoyer le moteur si nécessaire. (Ne jamais tenter de réassembler le Moteur, vous pouvez l'endommager et cela ne sera pas pris sous garantie.).
- Nettoyer la carrosserie avec un chiffon doux
- Enlever toutes les batteries en cas de non utilisation.

DÉPANNAGE

- | | |
|--|---|
| A. Le véhicule ne fonctionne plus du tout. | 1. Vérifier que la voiture et la radio soient allumées. |
| | 2. Remplacer les batteries |
| | 3. Vérifier qu'il n'y ai pas de pièces endommagées. |
| B. Le véhicule roule lentement | 1. Remplacer ou charger la batterie et/ou les batteries de la radio. |
| | 2. Etre sur que les pignons de la voiture soit ajustés correctement et que la couronne et le pignon moteur ne soient pas trop serrés. |
| | 3. Nettoyer toutes les bagues ou roulements à billes. |
| | 4. Vérifier si les pignons sont édentés ou sales. |
| C. Les gaz fonctionnent mais pas la direction | 1. Vérifier si le servo coince, essayer de le centrer à la main. |
| | 2. Vérifier l'ensemble du système de direction. |
| D. Cela tourne mais les gaz sont incontrôlables. | 1. Vérifier si certaines pièces sont endommagées |
| | 2. Remplacer ou charger la batterie et/ou les batteries de la radio |
| E. Le véhicule fait du bruit en roulant | 1. Vérifier l'entre-dent de la couronne et du pignon moteur. |
| | 2. Vérifier si les pignons sont édentés ou sales. |
| | 3. Nettoyer et huiler les bagues ou les roulements à billes. |



Notes:

A large rectangular area containing 25 horizontal dotted lines for taking notes.



Mauler



www.ftx-rc.com



FTX is an exclusive brand of CML Distribution, Saxon House, Saxon Business Park,
Hanbury Road, Bromsgrove, Worcestershire, B60 4AD England.
E-mail: info@ftx-rc.com